

Series Parallel Math Example 3

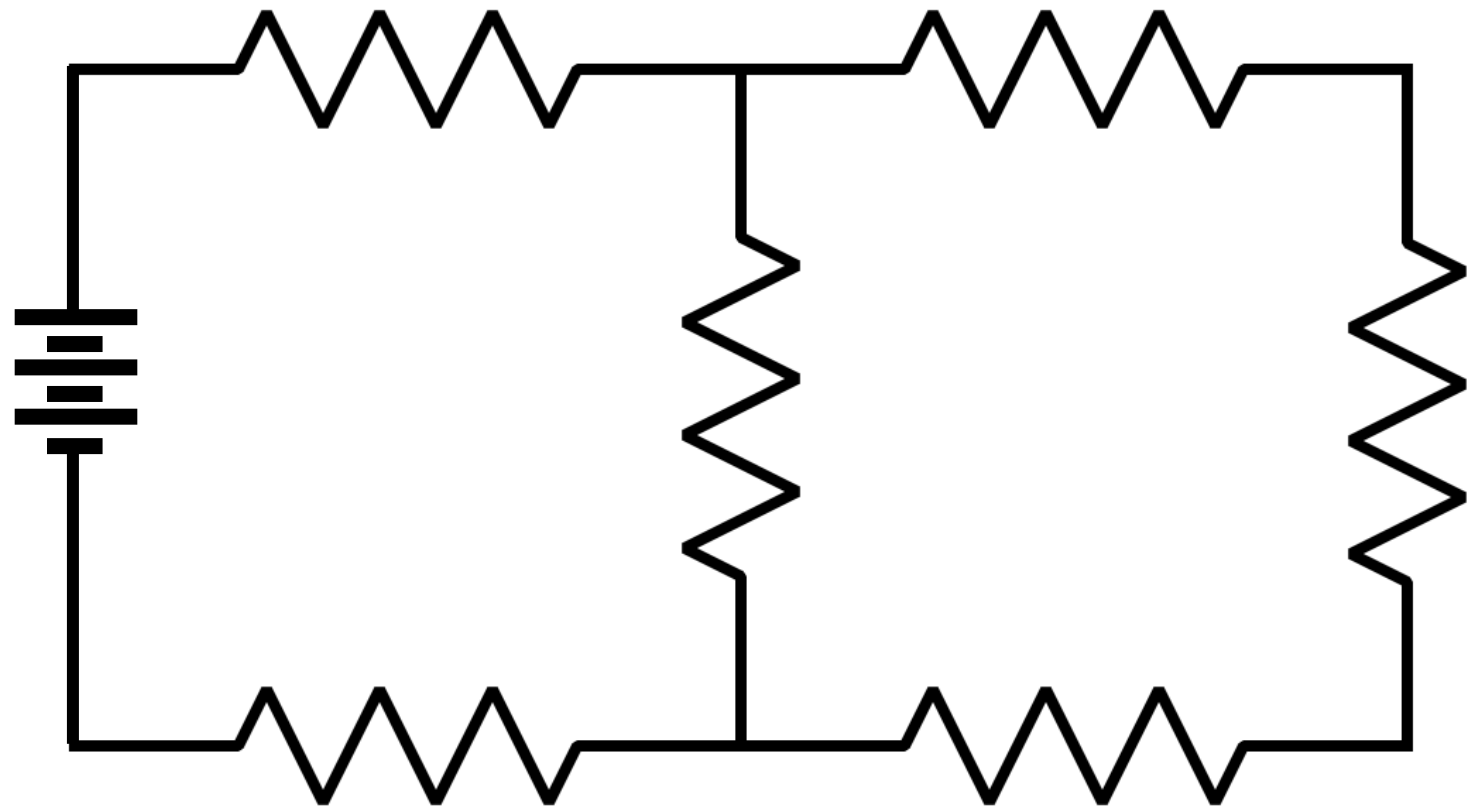

Math

Rule

$P_1 = \text{Watts}$
 $E_1 = \text{Volts}$
 $I_1 = \text{Amps}$
 $R_1 = 4 \text{ Ohms}$

$P_4 = \text{Watts}$
 $E_4 = \text{Volts}$
 $I_4 = \text{Amps}$
 $R_4 = 2 \text{ Ohms}$

$P_T = \text{Watts}$
 $E_T = 24 \text{ Volts}$
 $I_T = \text{Amps}$
 $R_T = \text{Ohms}$

$P_2 = \text{Watts}$
 $E_2 = \text{Volts}$
 $I_2 = \text{Amps}$
 $R_2 = 16 \text{ Ohms}$

$P_5 = \text{Watts}$
 $E_5 = \text{Volts}$
 $I_5 = \text{Amps}$
 $R_5 = 4 \text{ Ohms}$

$P_3 = \text{Watts}$
 $E_3 = \text{Volts}$
 $I_3 = \text{Amps}$
 $R_3 = 6 \text{ Ohms}$

$P_6 = \text{Watts}$
 $E_6 = \text{Volts}$
 $I_6 = \text{Amps}$
 $R_6 = 18 \text{ Ohms}$

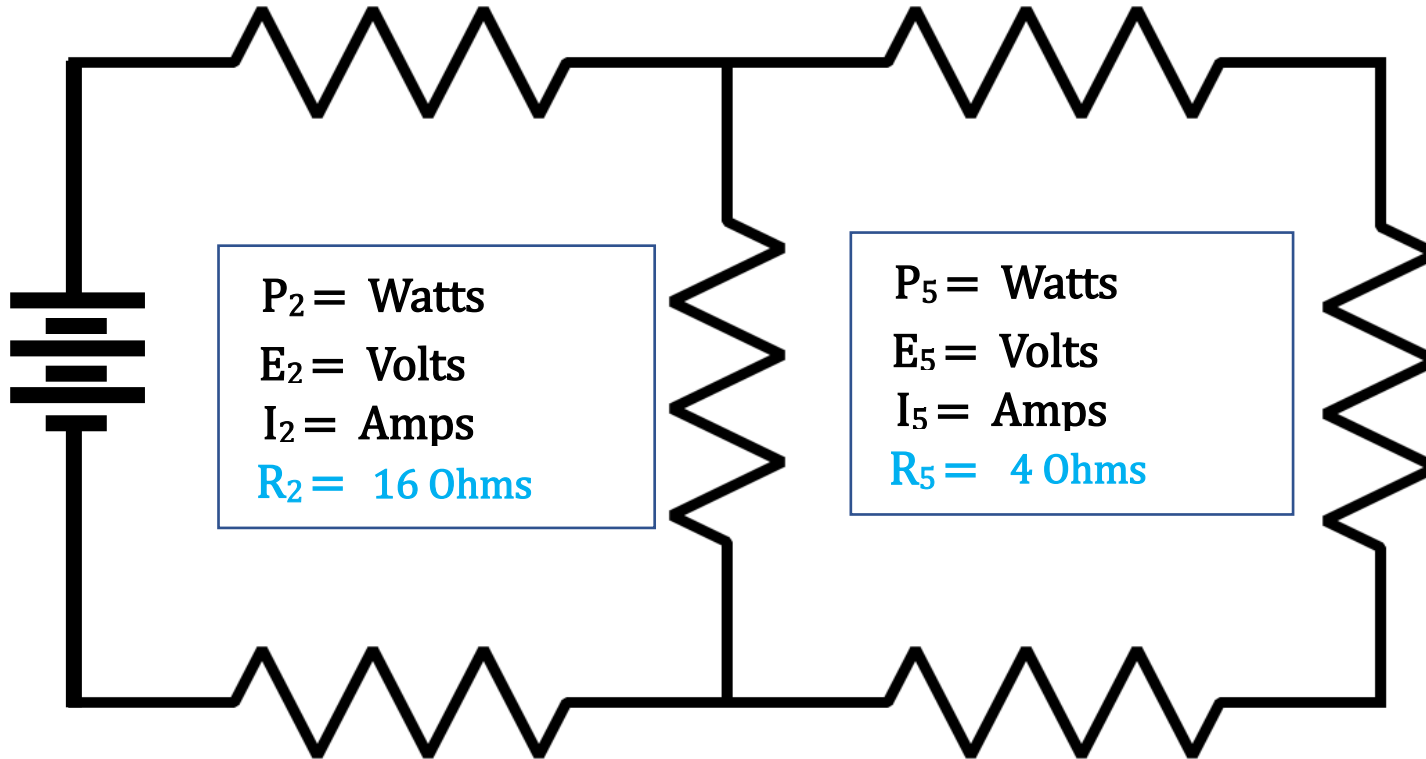

Math

Rule

$P_T = \text{Watts}$
 $E_T = 24 \text{ Volts}$
 $I_T = \text{Amps}$
 $R_T = \text{Ohms}$

$P_1 = \text{Watts}$
 $E_1 = \text{Volts}$
 $I_1 = \text{Amps}$
 $R_1 = 4 \text{ Ohms}$

$P_4 = \text{Watts}$
 $E_4 = \text{Volts}$
 $I_4 = \text{Amps}$
 $R_4 = 2 \text{ Ohms}$

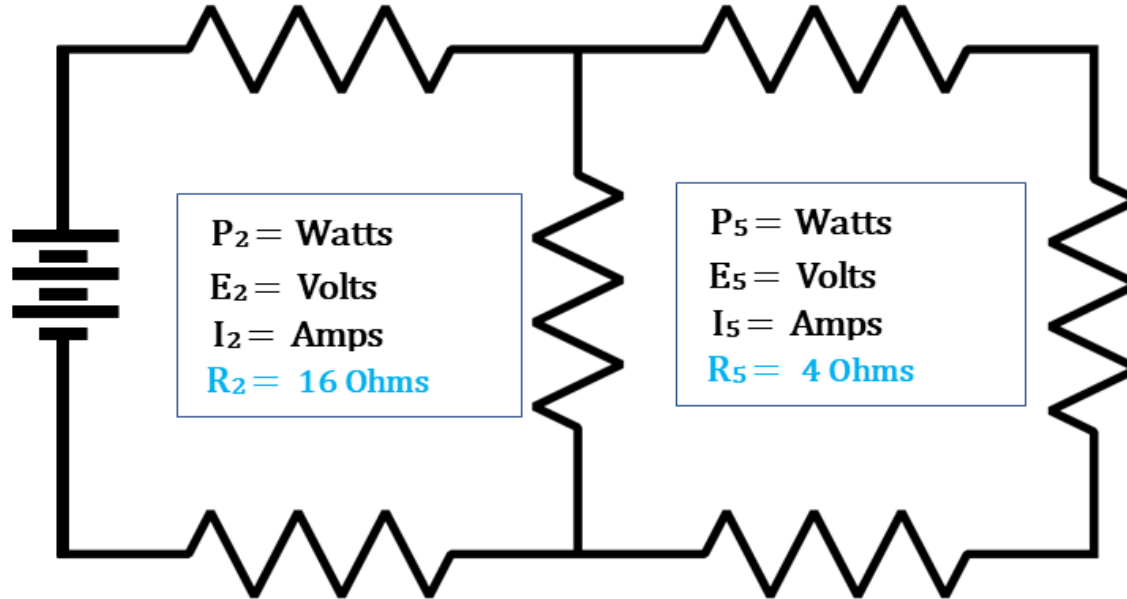

$P_2 = \text{Watts}$
 $E_2 = \text{Volts}$
 $I_2 = \text{Amps}$
 $R_2 = 16 \text{ Ohms}$

$P_5 = \text{Watts}$
 $E_5 = \text{Volts}$
 $I_5 = \text{Amps}$
 $R_5 = 4 \text{ Ohms}$

$P_3 = \text{Watts}$
 $E_3 = \text{Volts}$
 $I_3 = \text{Amps}$
 $R_3 = 6 \text{ Ohms}$

$P_6 = \text{Watts}$
 $E_6 = \text{Volts}$
 $I_6 = \text{Amps}$
 $R_6 = 18 \text{ Ohms}$

$$R_{4,5,6} = 2+4+18 = 24 \text{ Ohms}$$

$$R_{2,4,5,6} = \frac{R_2 \times R_{4,5,6}}{R_2 + R_{4,5,6}} = \frac{16 \times 24}{16+24} = \frac{384}{40} = 9.6 \text{ Ohms}$$

$$R_{2,4,5,6} = 9.6 \text{ Ohms}$$

$P_1 = \text{Watts}$

$E_1 = \text{Volts}$

$I_1 = \text{Amps}$

$R_1 = 4 \text{ Ohms}$

$R_{2,4,5,6} = 9.6 \text{ Ohms}$

$P_T = \text{Watts}$

$E_T = 24 \text{ Volts}$

$I_T = \text{Amps}$

$R_T = \text{Ohms}$

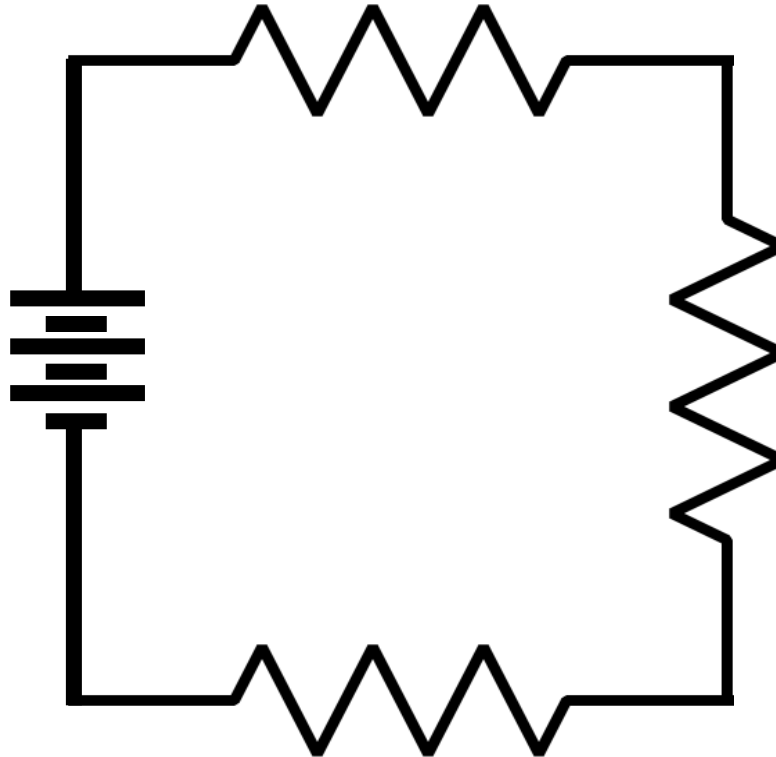

$P_{2,4,5,6} = \text{Watts}$

$E_{2,4,5,6} = \text{Volts}$

$I_{2,4,5,6} = \text{Amps}$

$R_{2,4,5,6} = 9.6 \text{ Ohms}$

$P_3 = \text{Watts}$

$E_3 = \text{Volts}$

$I_3 = \text{Amps}$

$R_3 = 6 \text{ Ohms}$

Math

$P_1 = \text{Watts}$

$E_1 = \text{Volts}$

$I_1 = \text{Amps}$

$R_1 = 4 \text{ Ohms}$

Rule

$P_T = \text{Watts}$

$E_T = 24 \text{ Volts}$

$I_T = \text{Amps}$

$R_T = \text{Ohms}$

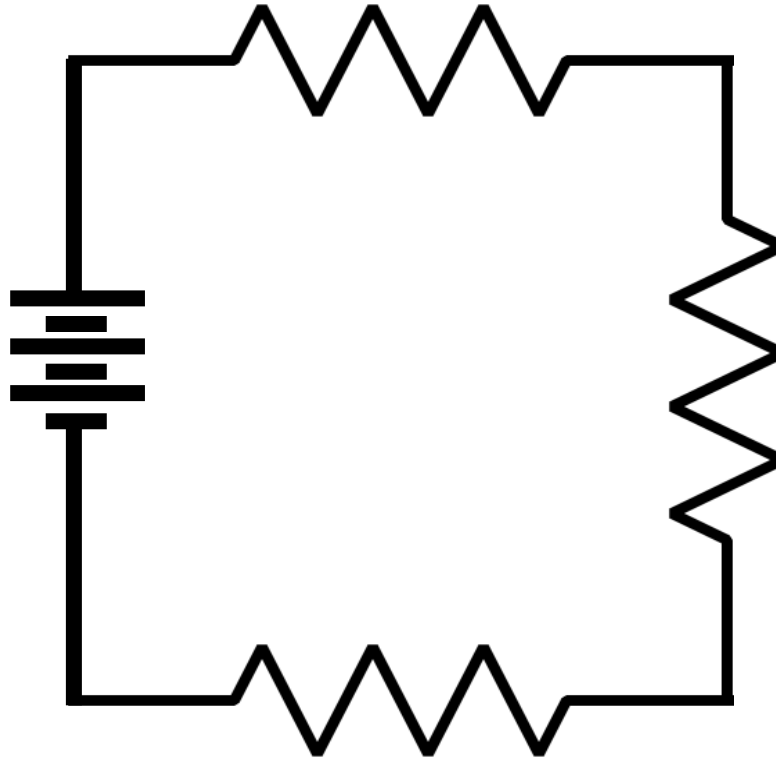

$P_{2,4,5,6} = \text{Watts}$

$E_{2.4.5.6} = \text{Volts}$

$I_{2.4.5.6} = \text{Amps}$

$R_{2,4,5,6} = 9.6 \text{ Ohms}$

$P_3 = \text{Watts}$

$E_3 = \text{Volts}$

$I_3 = \text{Amps}$

$R_3 = 6 \text{ Ohms}$

$P_1 = \text{Watts}$

$E_1 = \text{Volts}$

$I_1 = \text{Amps}$

$R_1 = 4 \text{ Ohms}$

$$R_T = R_1 + R_{2,4,5,6} + R_3 = 4 + 9.6 + 6 = 19.6 \text{ Ohms}$$

$P_T = \text{Watts}$

$E_T = 24 \text{ Volts}$

$I_T = \text{Amps}$

$R_T = 19.6 \text{ Ohms}$

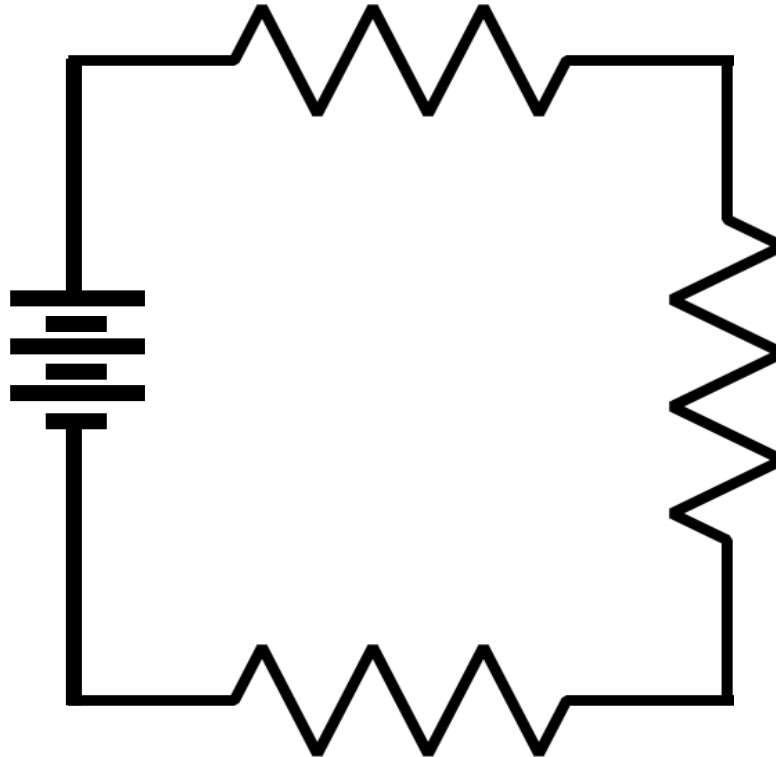

$P_{2,4,5,6} = \text{Watts}$

$E_{2,4,5,6} = \text{Volts}$

$I_{2,4,5,6} = \text{Amps}$

$R_{2,4,5,6} = 9.6 \text{ Ohms}$

$P_3 = \text{Watts}$

$E_3 = \text{Volts}$

$I_3 = \text{Amps}$

$R_3 = 6 \text{ Ohms}$

Math

Rule

$P_1 = \text{Watts}$
 $E_1 = \text{Volts}$
 $I_1 = \text{Amps}$
 $R_1 = 4 \text{ Ohms}$

$P_4 = \text{Watts}$
 $E_4 = \text{Volts}$
 $I_4 = \text{Amps}$
 $R_4 = 2 \text{ Ohms}$

$P_T = \text{Watts}$
 $E_T = 24 \text{ Volts}$
 $I_T = \text{Amps}$
 $R_T = 19.6 \text{ Ohms}$

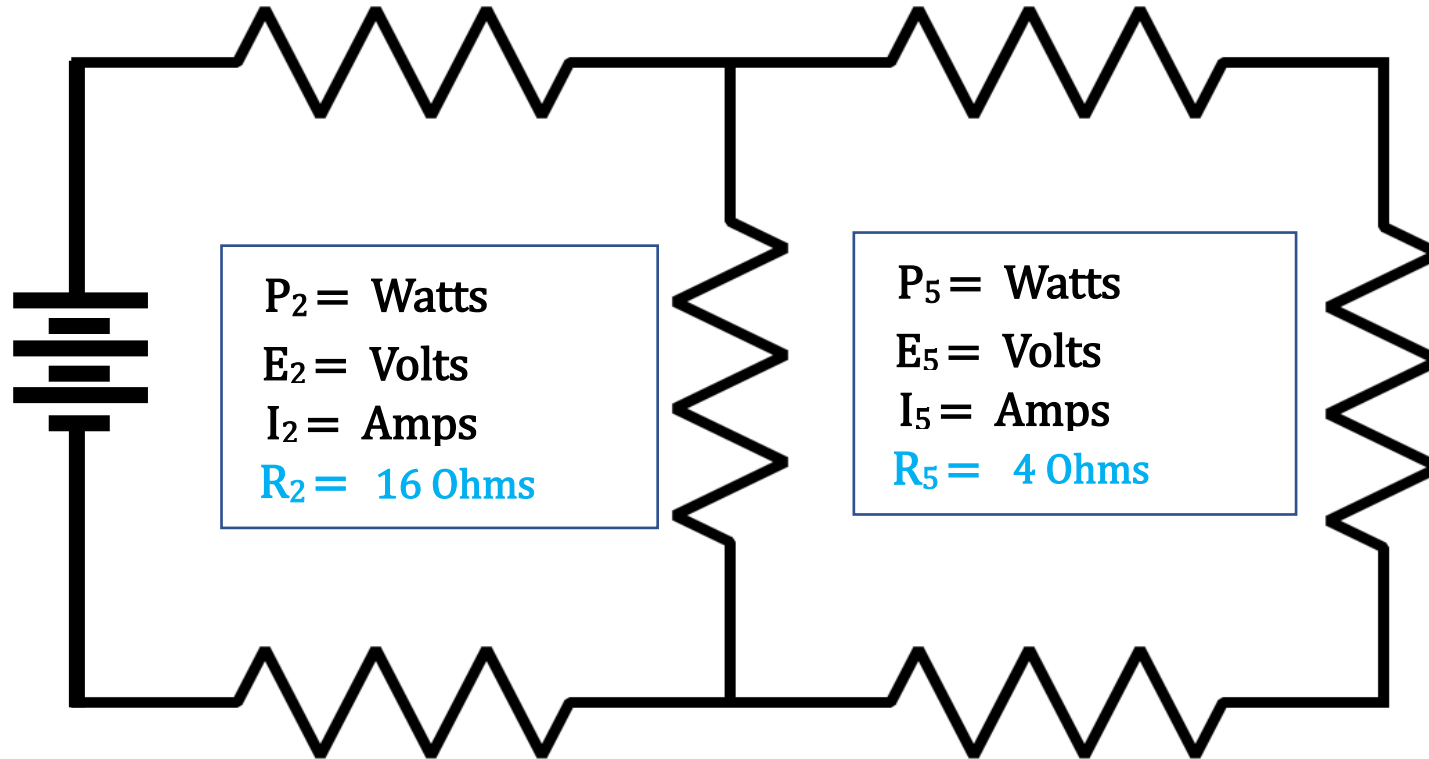

$P_2 = \text{Watts}$
 $E_2 = \text{Volts}$
 $I_2 = \text{Amps}$
 $R_2 = 16 \text{ Ohms}$

$P_5 = \text{Watts}$
 $E_5 = \text{Volts}$
 $I_5 = \text{Amps}$
 $R_5 = 4 \text{ Ohms}$

$P_3 = \text{Watts}$
 $E_3 = \text{Volts}$
 $I_3 = \text{Amps}$
 $R_3 = 6 \text{ Ohms}$

$P_6 = \text{Watts}$
 $E_6 = \text{Volts}$
 $I_6 = \text{Amps}$
 $R_6 = 18 \text{ Ohms}$

Math

Rule

$P_1 =$ Watts
 $E_1 =$ Volts
 $I_1 =$ Amps
 $R_1 = 4$ Ohms

$P_4 =$ Watts
 $E_4 =$ Volts
 $I_4 =$ Amps
 $R_4 = 2$ Ohms

$P_T = 29.28$ Watts
 $E_T = 24$ Volts
 $I_T = 1.22$ Amps
 $R_T = 19.6$ Ohms

$P_2 =$ Watts
 $E_2 =$ Volts
 $I_2 =$ Amps
 $R_2 = 16$ Ohms

$P_5 =$ Watts
 $E_5 =$ Volts
 $I_5 =$ Amps
 $R_5 = 4$ Ohms

$P_3 =$ Watts
 $E_3 =$ Volts
 $I_3 =$ Amps
 $R_3 = 6$ Ohms

$P_6 =$ Watts
 $E_6 =$ Volts
 $I_6 =$ Amps
 $R_6 = 18$ Ohms

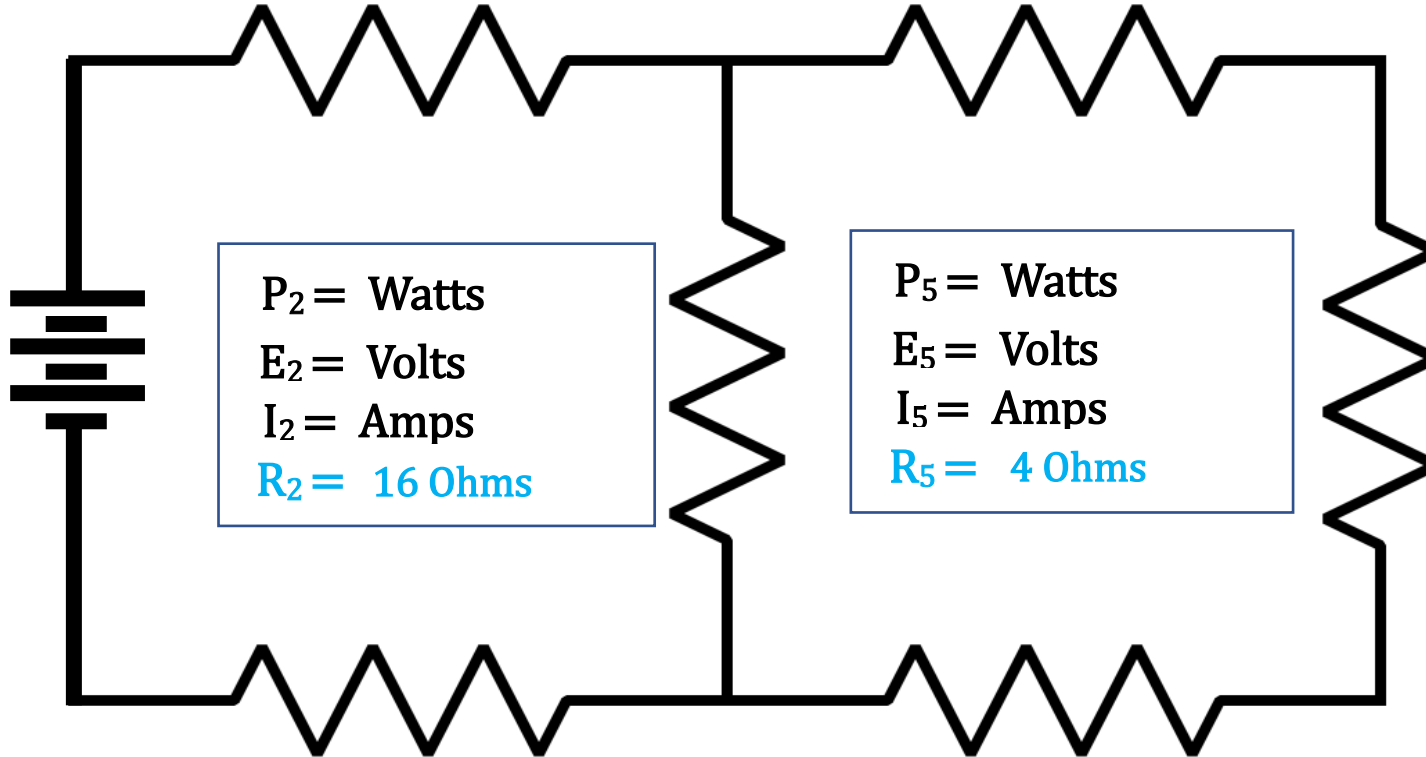

Math

Rule

$P_1 = \text{Watts}$
 $E_1 = \text{Volts}$
 $I_1 = 1.22 \text{ Amps}$
 $R_1 = 4 \text{ Ohms}$

$P_4 = \text{Watts}$
 $E_4 = \text{Volts}$
 $I_4 = \text{Amps}$
 $R_4 = 2 \text{ Ohms}$

$P_T = 29.28 \text{ Watts}$
 $E_T = 24 \text{ Volts}$
 $I_T = 1.22 \text{ Amps}$
 $R_T = 19.6 \text{ Ohms}$

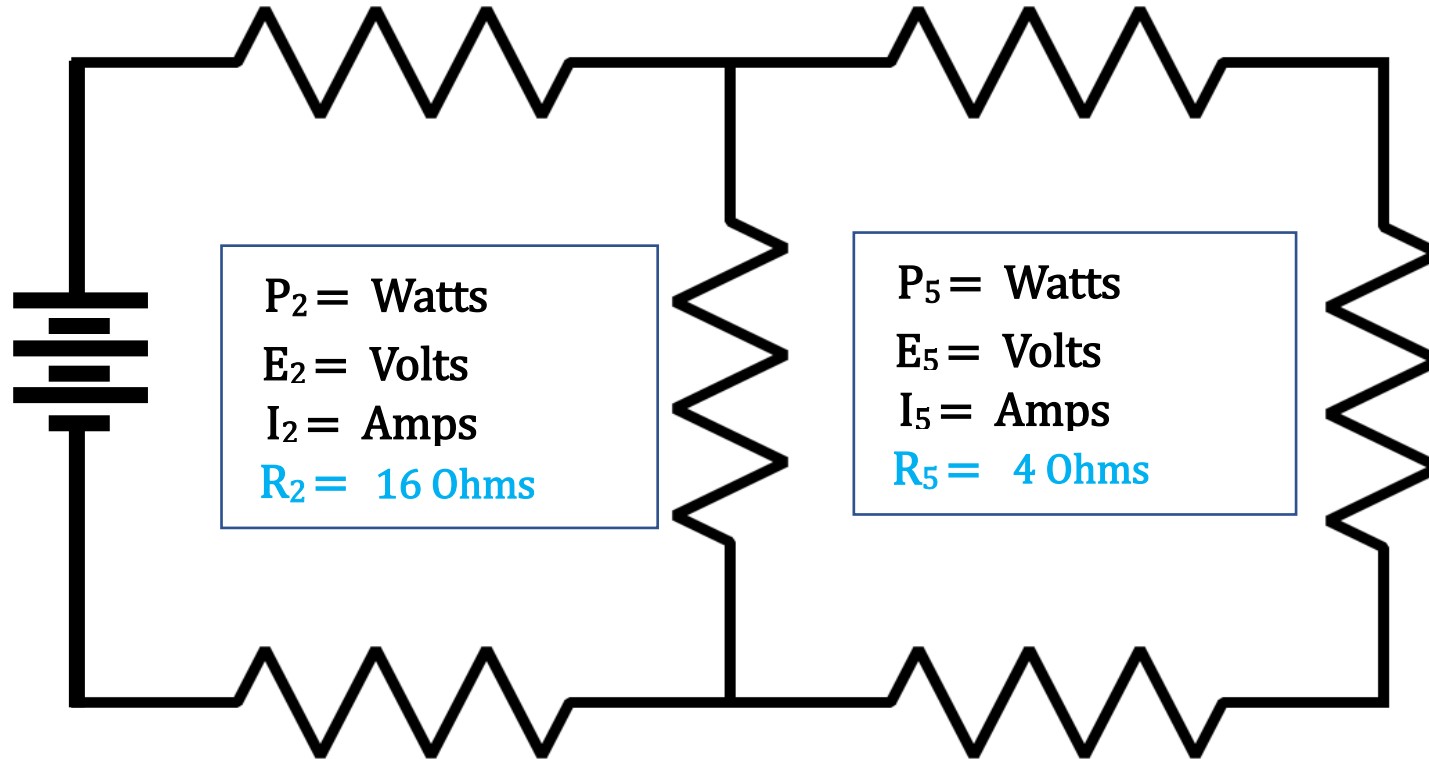

$P_2 = \text{Watts}$
 $E_2 = \text{Volts}$
 $I_2 = \text{Amps}$
 $R_2 = 16 \text{ Ohms}$

$P_5 = \text{Watts}$
 $E_5 = \text{Volts}$
 $I_5 = \text{Amps}$
 $R_5 = 4 \text{ Ohms}$

$P_3 = \text{Watts}$
 $E_3 = \text{Volts}$
 $I_3 = 1.22 \text{ Amps}$
 $R_3 = 6 \text{ Ohms}$

$P_6 = \text{Watts}$
 $E_6 = \text{Volts}$
 $I_6 = \text{Amps}$
 $R_6 = 18 \text{ Ohms}$

Math

Rule

$P_1 = 5.95$ Watts
 $E_1 = 4.88$ Volts
 $I_1 = 1.22$ Amps
 $R_1 = 4$ Ohms

$P_4 =$ Watts
 $E_4 =$ Volts
 $I_4 =$ Amps
 $R_4 = 2$ Ohms

$P_T = 29.28$ Watts
 $E_T = 24$ Volts
 $I_T = 1.22$ Amps
 $R_T = 19.6$ Ohms

$P_2 =$ Watts
 $E_2 =$ Volts
 $I_2 =$ Amps
 $R_2 = 16$ Ohms

$P_5 =$ Watts
 $E_5 =$ Volts
 $I_5 =$ Amps
 $R_5 = 4$ Ohms

$P_3 =$ Watts
 $E_3 =$ Volts
 $I_3 = 1.22$ Amps
 $R_3 = 6$ Ohms

$P_6 =$ Watts
 $E_6 =$ Volts
 $I_6 =$ Amps
 $R_6 = 18$ Ohms

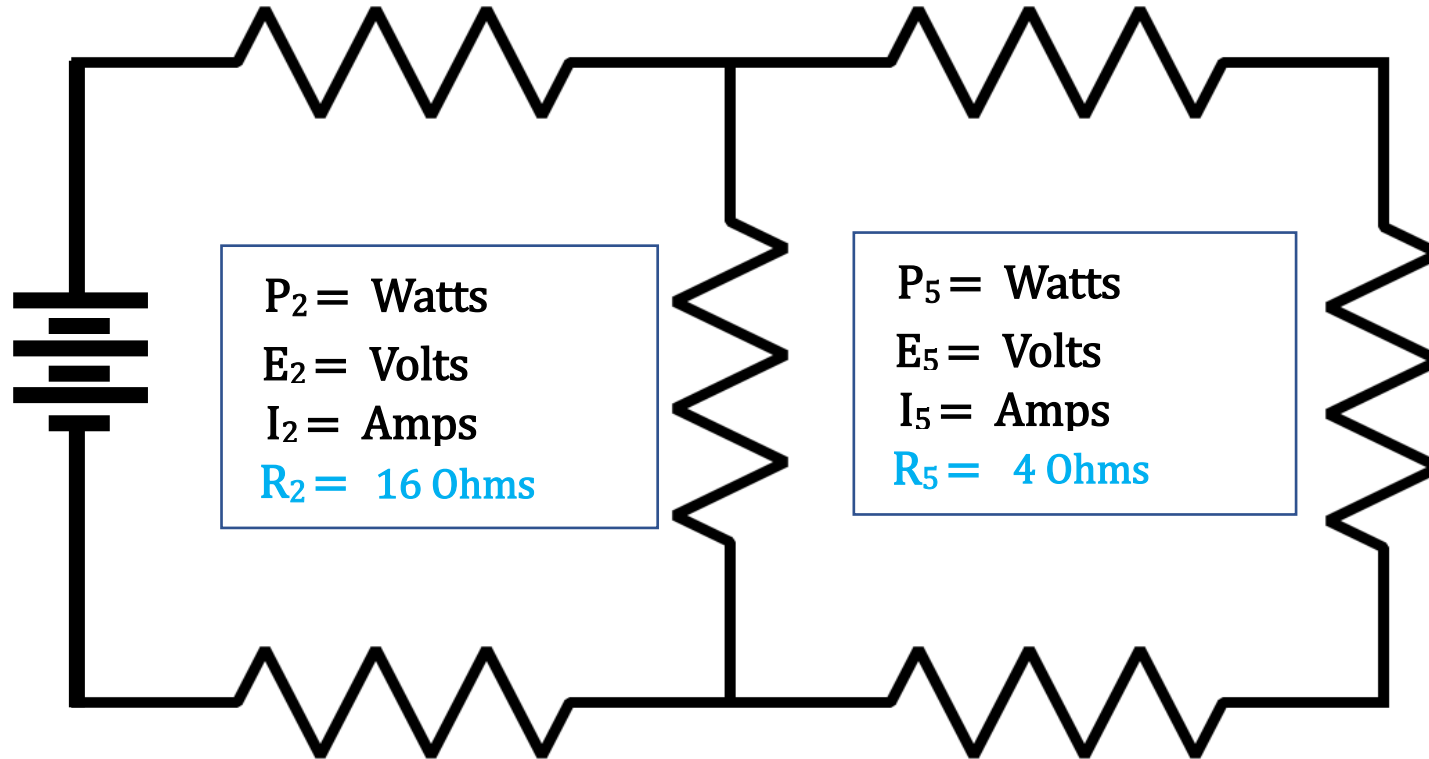

Math

Rule

$P_1 = 5.95$ Watts
 $E_1 = 4.88$ Volts
 $I_1 = 1.22$ Amps
 $R_1 = 4$ Ohms

$P_4 =$ Watts
 $E_4 =$ Volts
 $I_4 =$ Amps
 $R_4 = 2$ Ohms

$P_T = 29.28$ Watts
 $E_T = 24$ Volts
 $I_T = 1.22$ Amps
 $R_T = 19.6$ Ohms

$P_2 =$ Watts
 $E_2 =$ Volts
 $I_2 =$ Amps
 $R_2 = 16$ Ohms

$P_5 =$ Watts
 $E_5 =$ Volts
 $I_5 =$ Amps
 $R_5 = 4$ Ohms

$P_3 = 8.93$ Watts
 $E_3 = 7.32$ Volts
 $I_3 = 1.22$ Amps
 $R_3 = 6$ Ohms

$P_6 =$ Watts
 $E_6 =$ Volts
 $I_6 =$ Amps
 $R_6 = 18$ Ohms

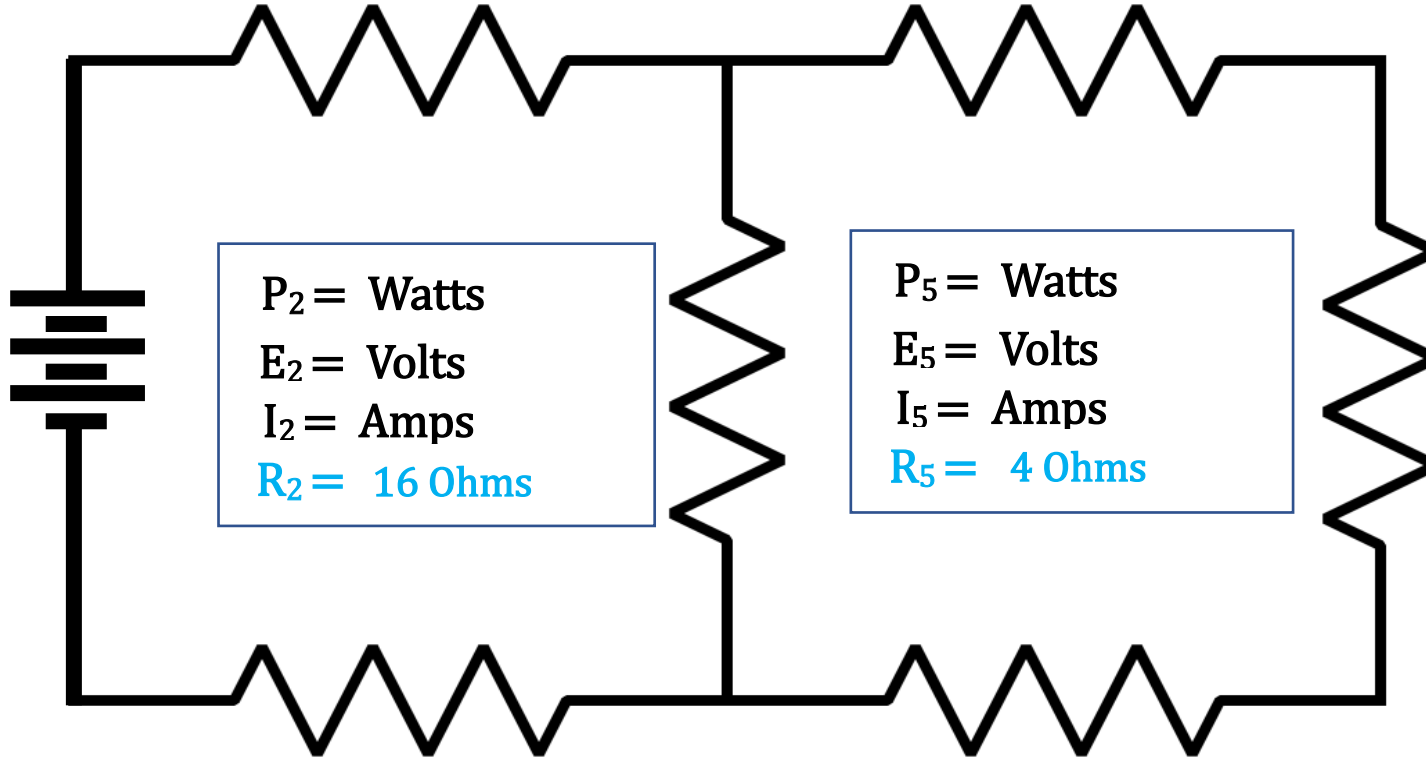

$$P_1 = 5.95 \text{ Watts}$$

$$E_1 = 4.88 \text{ Volts}$$

$$I_1 = 1.22 \text{ Amps}$$

$$R_1 = 4 \text{ Ohms}$$

$$P_T = 29.28 \text{ Watts}$$

$$E_T = 24 \text{ Volts}$$

$$I_T = 1.22 \text{ Amps}$$

$$R_T = 19.6 \text{ Ohms}$$

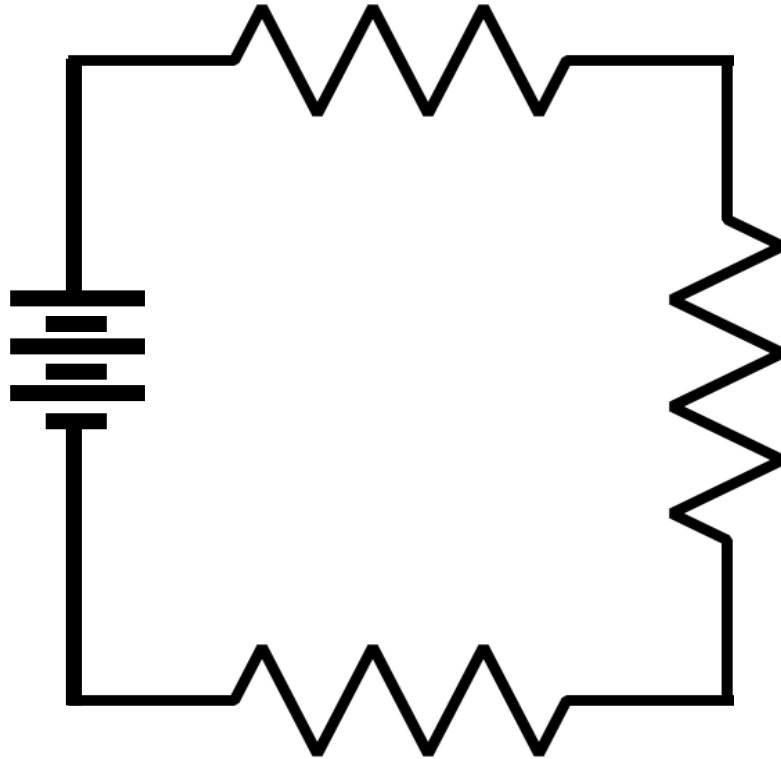

$$P_{2,4,5,6} = \text{Watts}$$

$$E_{2,4,5,6} = \text{Volts}$$

$$I_{2,4,5,6} = \text{Amps}$$

$$R_{2,4,5,6} = 9.6 \text{ Ohms}$$

$$P_3 = 8.93 \text{ Watts}$$

$$E_3 = 7.32 \text{ Volts}$$

$$I_3 = 1.22 \text{ Amps}$$

$$R_3 = 6 \text{ Ohms}$$

$$P_1 = 5.95 \text{ Watts}$$

$$E_1 = 4.88 \text{ Volts}$$

$$I_1 = 1.22 \text{ Amps}$$

$$R_1 = 4 \text{ Ohms}$$

$$E_{2,(4,5,6)} = E_T - E_1 - E_3$$

$$E_{2,(4,5,6)} = 24 - 4.88 - 7.32 = 11.8 \text{ Volts}$$

$$P_T = 29.28 \text{ Watts}$$

$$E_T = 24 \text{ Volts}$$

$$I_T = 1.22 \text{ Amps}$$

$$R_T = 19.6 \text{ Ohms}$$

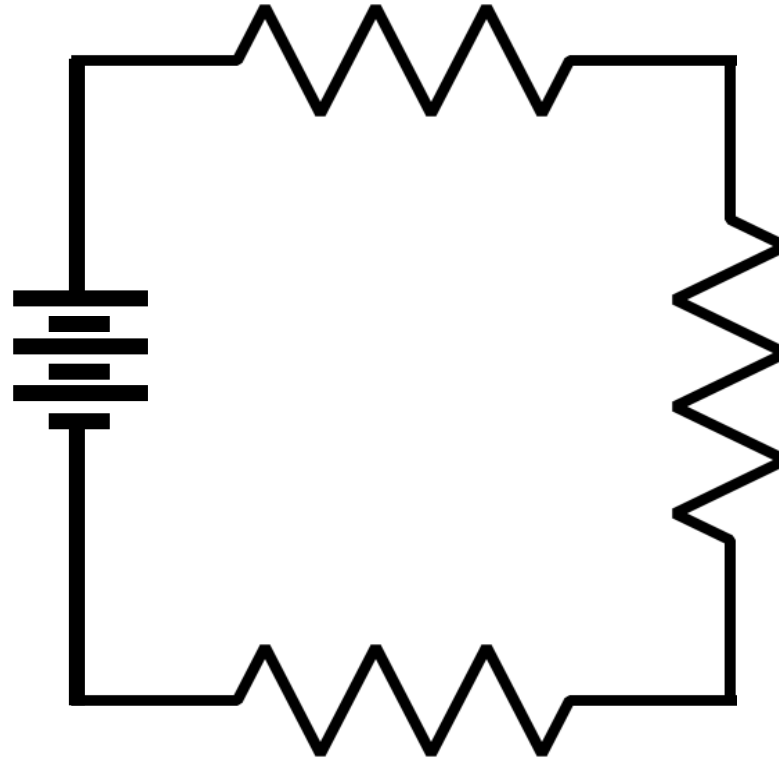

$$P_{2,4,5,6} = \text{Watts}$$

$$E_{2,4,5,6} = \text{Volts}$$

$$I_{2,4,5,6} = \text{Amps}$$

$$R_{2,4,5,6} = 9.6 \text{ Ohms}$$

$$P_3 = 8.93 \text{ Watts}$$

$$E_3 = 7.32 \text{ Volts}$$

$$I_3 = 1.22 \text{ Amps}$$

$$R_3 = 6 \text{ Ohms}$$

$$P_1 = 5.95 \text{ Watts}$$

$$E_1 = 4.88 \text{ Volts}$$

$$I_1 = 1.22 \text{ Amps}$$

$$R_1 = 4 \text{ Ohms}$$

$$E_{2,(4,5,6)} = E_T - E_1 - E_3$$

$$E_{2,(4,5,6)} = 24 - 4.88 - 7.32 = 11.8 \text{ Volts}$$

$$P_T = 29.28 \text{ Watts}$$

$$E_T = 24 \text{ Volts}$$

$$I_T = 1.22 \text{ Amps}$$

$$R_T = 19.6 \text{ Ohms}$$

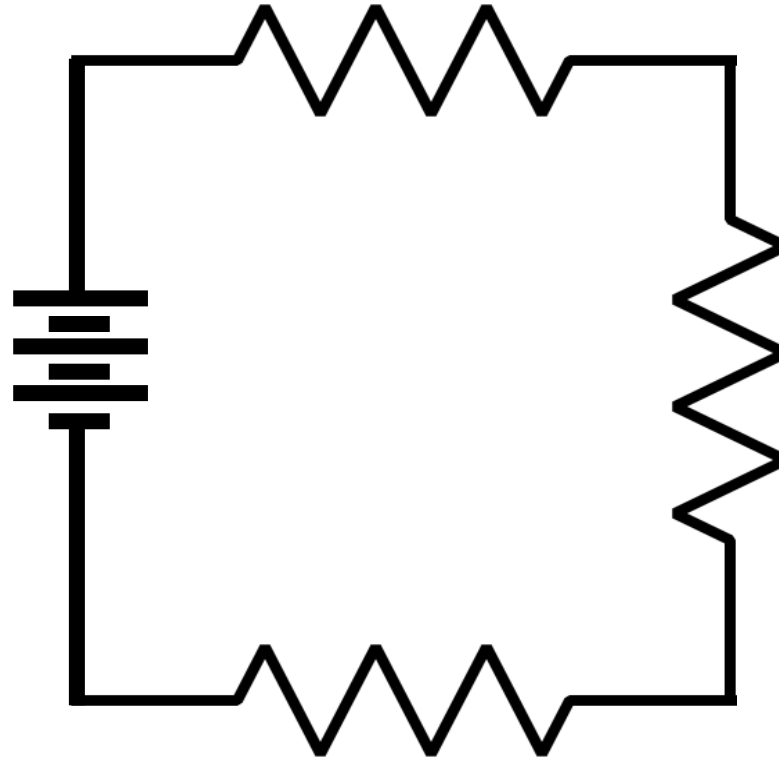

$$P_{2,4,5,6} = \text{Watts}$$

$$E_{2,4,5,6} = 11.8$$

$$I_{2,4,5,6} = \text{Amps}$$

$$R_{2,4,5,6} = 9.6 \text{ Ohms}$$

$$P_3 = 8.93 \text{ Watts}$$

$$E_3 = 7.32 \text{ Volts}$$

$$I_3 = 1.22 \text{ Amps}$$

$$R_3 = 6 \text{ Ohms}$$

Math

Rule

$P_1 = 5.95$ Watts
 $E_1 = 4.88$ Volts
 $I_1 = 1.22$ Amps
 $R_1 = 4$ Ohms

$P_4 =$ Watts
 $E_4 =$ Volts
 $I_4 =$ Amps
 $R_4 = 2$ Ohms

$P_T = 29.28$ Watts
 $E_T = 24$ Volts
 $I_T = 1.22$ Amps
 $R_T = 19.6$ Ohms

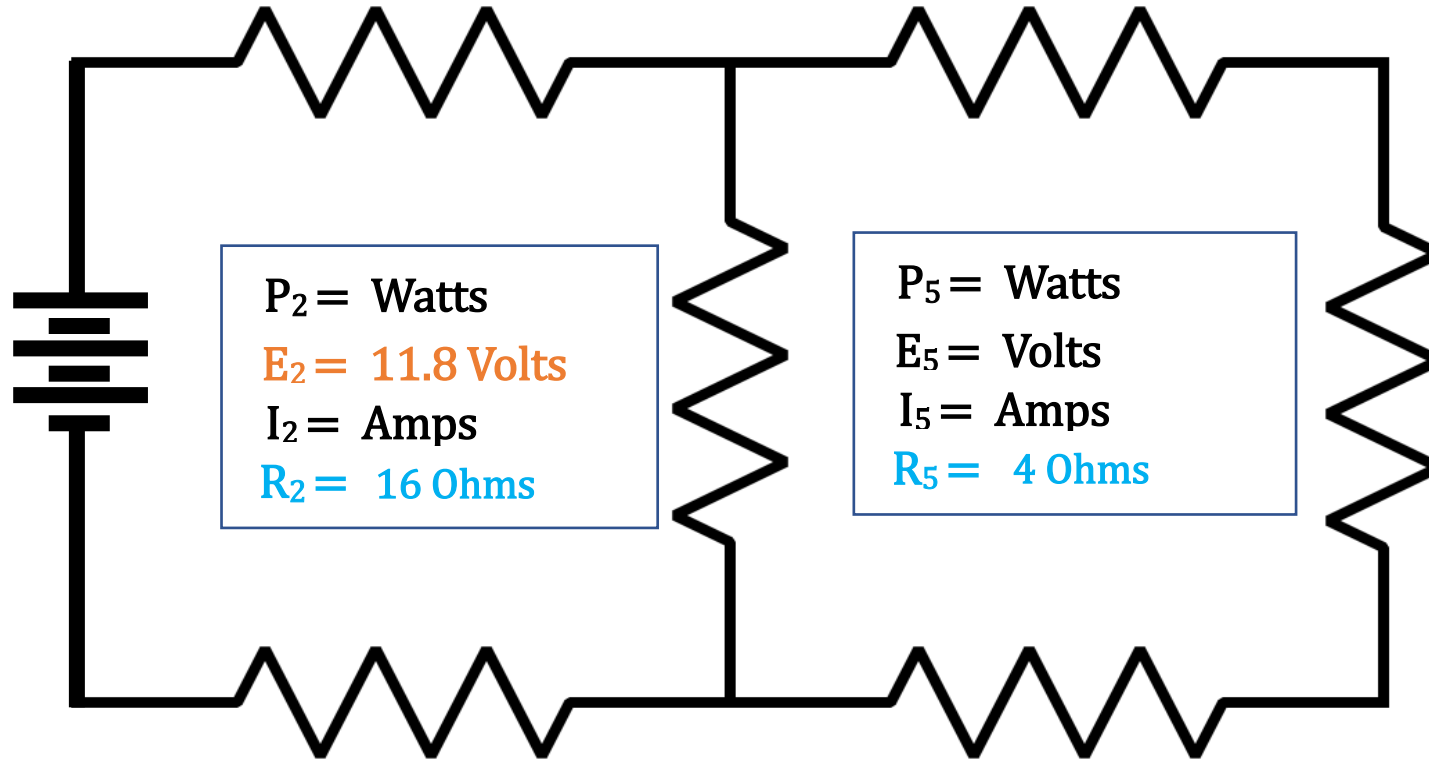

$P_2 =$ Watts
 $E_2 = 11.8$ Volts
 $I_2 =$ Amps
 $R_2 = 16$ Ohms

$P_5 =$ Watts
 $E_5 =$ Volts
 $I_5 =$ Amps
 $R_5 = 4$ Ohms

$P_3 = 8.93$ Watts
 $E_3 = 7.32$ Volts
 $I_3 = 1.22$ Amps
 $R_3 = 6$ Ohms

$P_6 =$ Watts
 $E_6 =$ Volts
 $I_6 =$ Amps
 $R_6 = 18$ Ohms

Math

Rule

$P_1 = 5.95$ Watts
 $E_1 = 4.88$ Volts
 $I_1 = 1.22$ Amps
 $R_1 = 4$ Ohms

$P_4 =$ Watts
 $E_4 =$ Volts
 $I_4 =$ Amps
 $R_4 = 2$ Ohms

$P_T = 29.28$ Watts
 $E_T = 24$ Volts
 $I_T = 1.22$ Amps
 $R_T = 19.6$ Ohms

$P_2 = 8.73$ Watts
 $E_2 = 11.8$ Volts
 $I_2 = .74$ Amps
 $R_2 = 16$ Ohms

$P_5 =$ Watts
 $E_5 =$ Volts
 $I_5 =$ Amps
 $R_5 = 4$ Ohms

$P_3 = 8.93$ Watts
 $E_3 = 7.32$ Volts
 $I_3 = 1.22$ Amps
 $R_3 = 6$ Ohms

$P_6 =$ Watts
 $E_6 =$ Volts
 $I_6 =$ Amps
 $R_6 = 18$ Ohms

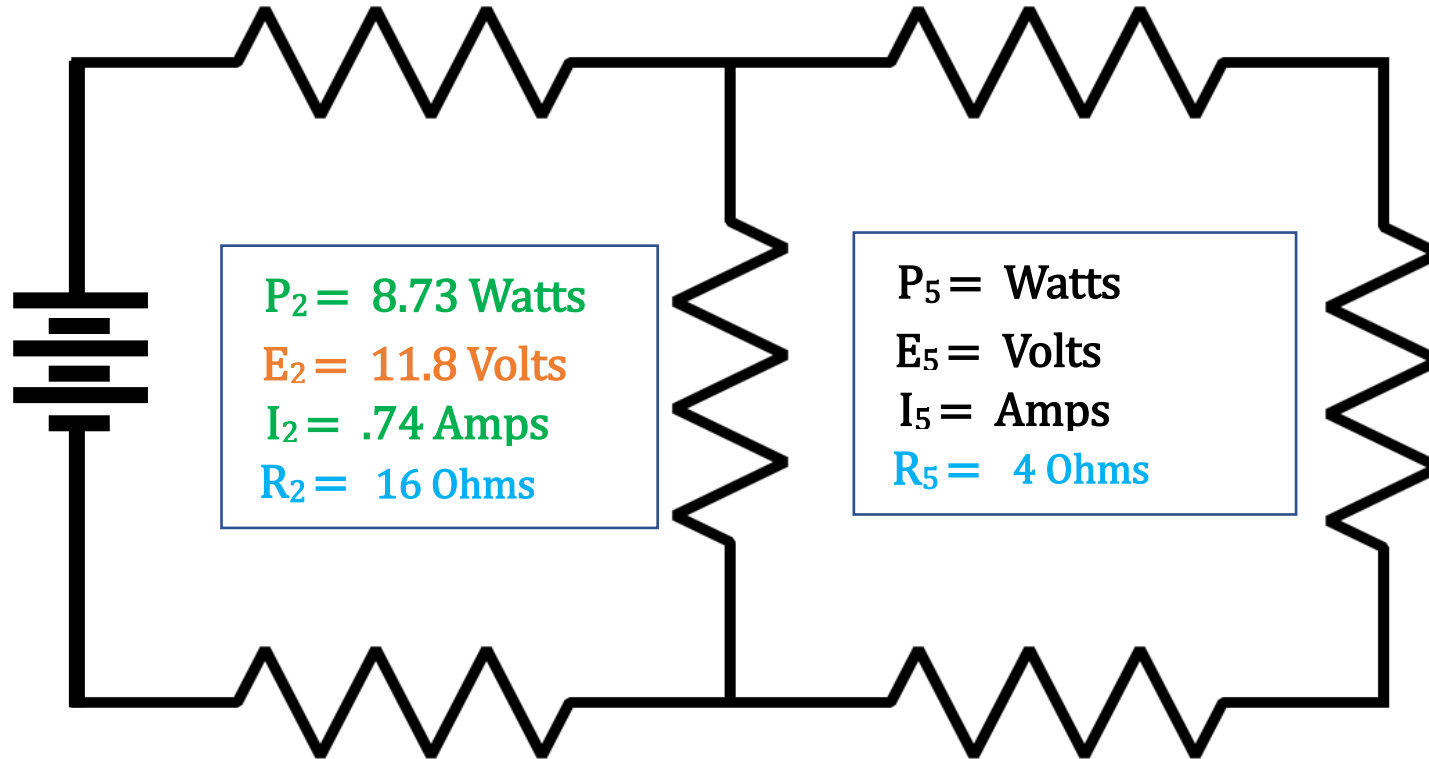

Math

Rule

$P_1 = 5.95$ Watts
 $E_1 = 4.88$ Volts
 $I_1 = 1.22$ Amps
 $R_1 = 4$ Ohms

$P_4 =$ Watts
 $E_4 =$ Volts
 $I_4 =$ Amps
 $R_4 = 2$ Ohms

$P_T = 29.28$ Watts
 $E_T = 24$ Volts
 $I_T = 1.22$ Amps
 $R_T = 19.6$ Ohms

$P_2 = 8.73$ Watts
 $E_2 = 11.8$ Volts
 $I_2 = .74$ Amps
 $R_2 = 16$ Ohms

$P_5 =$ Watts
 $E_5 =$ Volts
 $I_5 =$ Amps
 $R_5 = 4$ Ohms

$I_{(4,5,6)} = I_T - I_2$
 $I_{(4,5,6)} = 1.22 - .74 = .48$ Amps

$P_3 = 8.93$ Watts
 $E_3 = 7.32$ Volts
 $I_3 = 1.22$ Amps
 $R_3 = 6$ Ohms

$P_6 =$ Watts
 $E_6 =$ Volts
 $I_6 =$ Amps
 $R_6 = 18$ Ohms

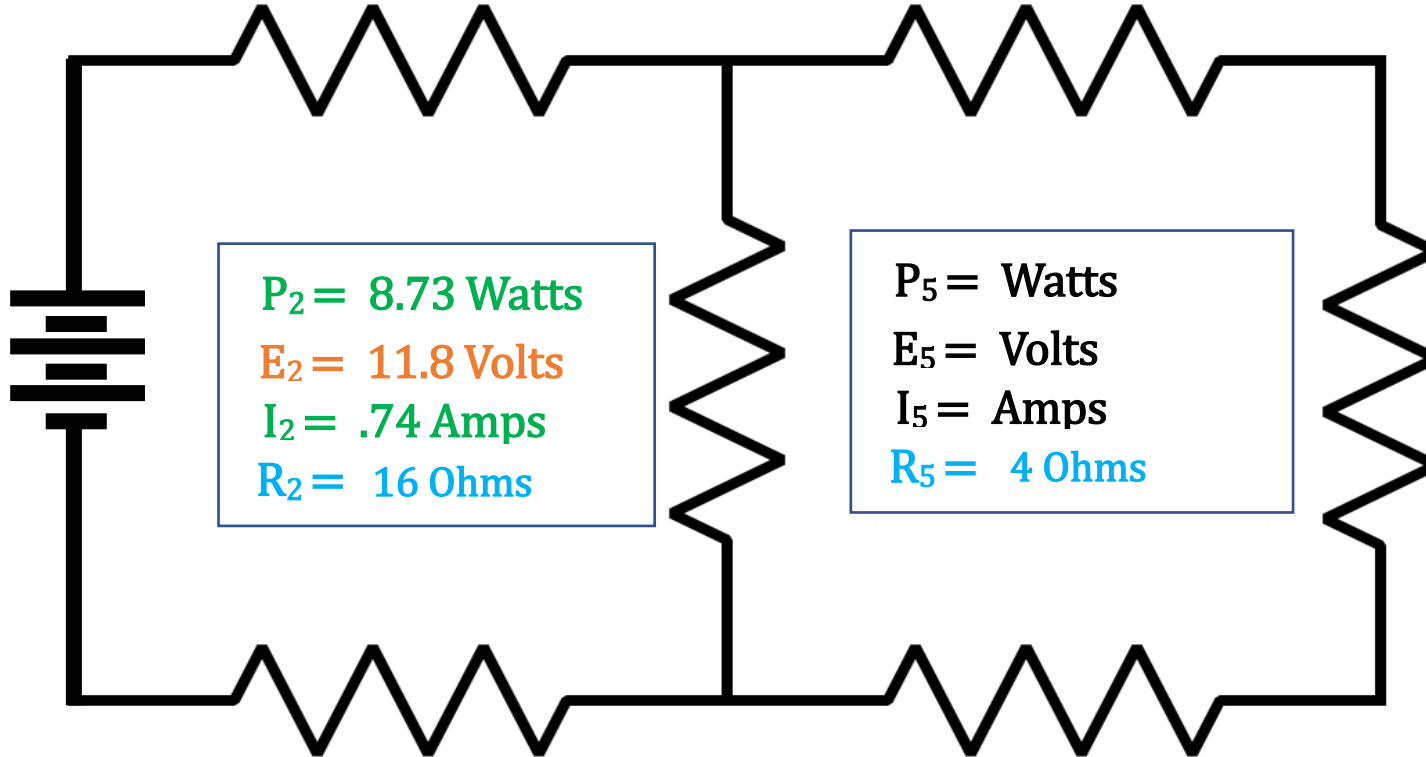

Math

Rule

$P_1 = 5.95$ Watts
 $E_1 = 4.88$ Volts
 $I_1 = 1.22$ Amps
 $R_1 = 4$ Ohms

$P_4 =$ Watts
 $E_4 =$ Volts
 $I_4 = .48$ Amps
 $R_4 = 2$ Ohms

$P_T = 29.28$ Watts
 $E_T = 24$ Volts
 $I_T = 1.22$ Amps
 $R_T = 19.6$ Ohms

$P_2 = 8.73$ Watts
 $E_2 = 11.8$ Volts
 $I_2 = .74$ Amps
 $R_2 = 16$ Ohms

$P_5 =$ Watts
 $E_5 =$ Volts
 $I_5 = .48$ Amps
 $R_5 = 4$ Ohms

$$I_{(4,5,6)} = I_T - I_2$$
$$I_{(4,5,6)} = 1.22 - .74 = .48 \text{ Amps}$$

$P_3 = 8.93$ Watts
 $E_3 = 7.32$ Volts
 $I_3 = 1.22$ Amps
 $R_3 = 6$ Ohms

$P_6 =$ Watts
 $E_6 =$ Volts
 $I_6 = .48$ Amps
 $R_6 = 18$ Ohms

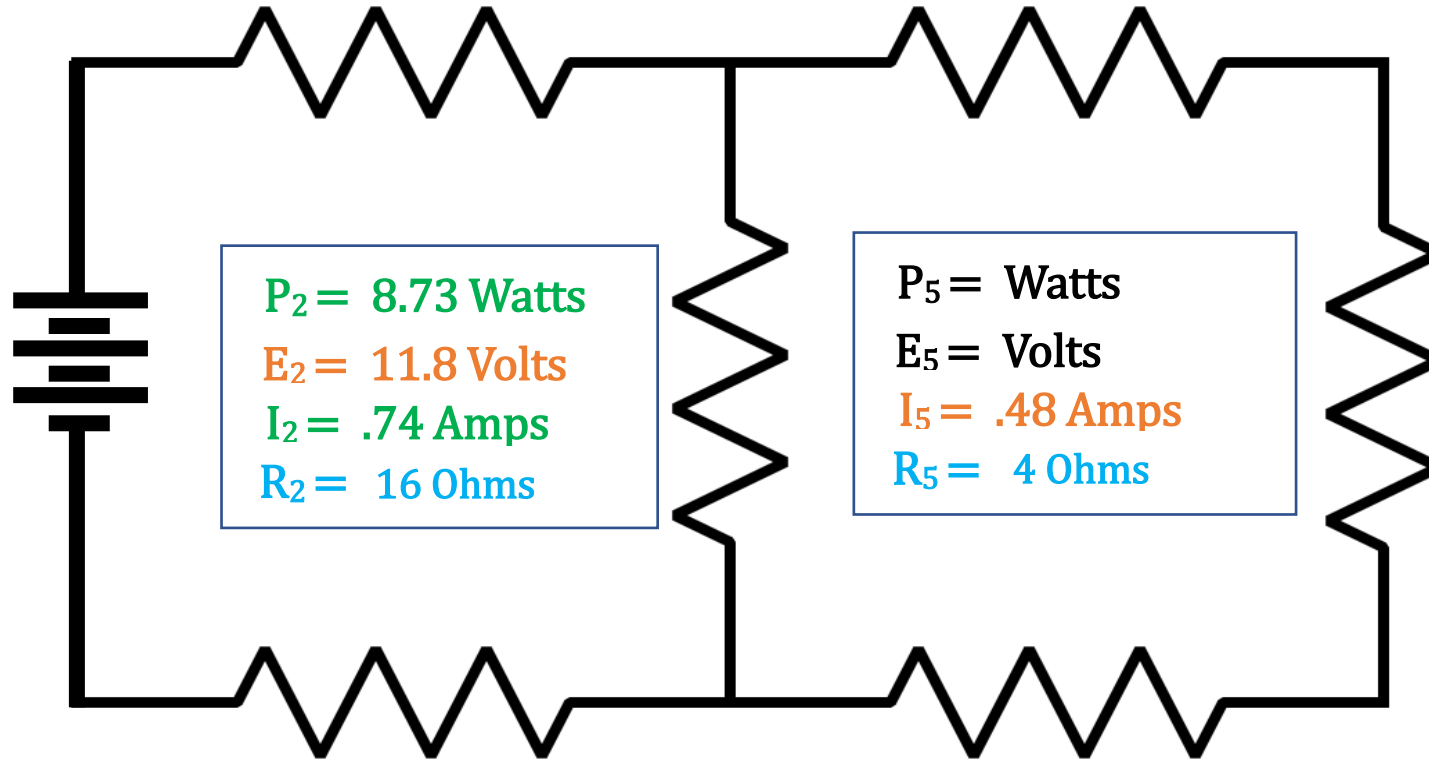

Math

Rule

$P_T = 29.28$ Watts
 $E_T = 24$ Volts
 $I_T = 1.22$ Amps
 $R_T = 19.6$ Ohms

$P_1 = 5.95$ Watts
 $E_1 = 4.88$ Volts
 $I_1 = 1.22$ Amps
 $R_1 = 4$ Ohms

$P_4 =$ Watts
 $E_4 =$ Volts
 $I_4 = .48$ Amps
 $R_4 = 2$ Ohms

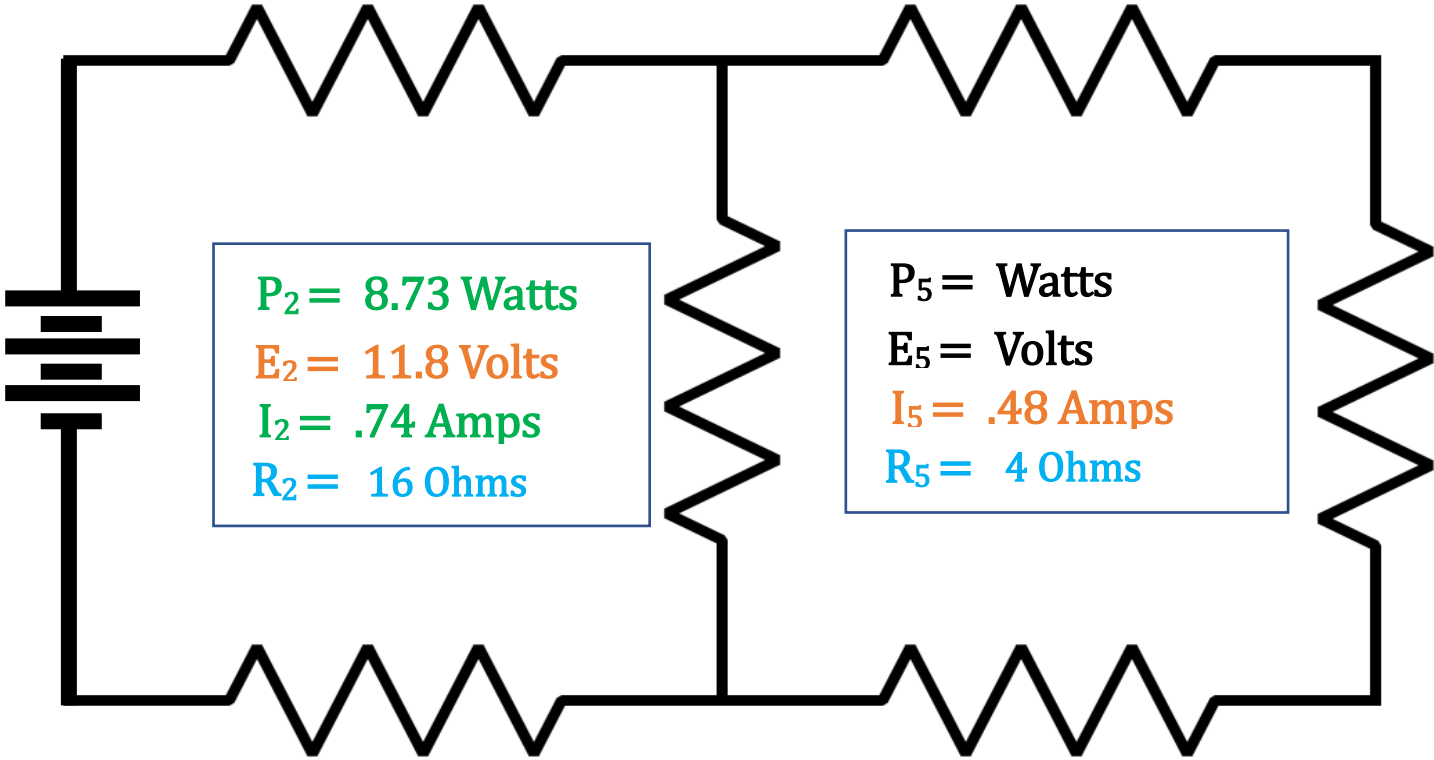

$P_2 = 8.73$ Watts
 $E_2 = 11.8$ Volts
 $I_2 = .74$ Amps
 $R_2 = 16$ Ohms

$P_5 =$ Watts
 $E_5 =$ Volts
 $I_5 = .48$ Amps
 $R_5 = 4$ Ohms

$P_3 = 8.93$ Watts
 $E_3 = 7.32$ Volts
 $I_3 = 1.22$ Amps
 $R_3 = 6$ Ohms

$P_6 =$ Watts
 $E_6 =$ Volts
 $I_6 = .48$ Amps
 $R_6 = 18$ Ohms

Math

Rule

$P_T = 29.28$ Watts
 $E_T = 24$ Volts
 $I_T = 1.22$ Amps
 $R_T = 19.6$ Ohms

$P_1 = 5.95$ Watts
 $E_1 = 4.88$ Volts
 $I_1 = 1.22$ Amps
 $R_1 = 4$ Ohms

$P_4 = .46$ Watts
 $E_4 = .96$ Volts
 $I_4 = .48$ Amps
 $R_4 = 2$ Ohms

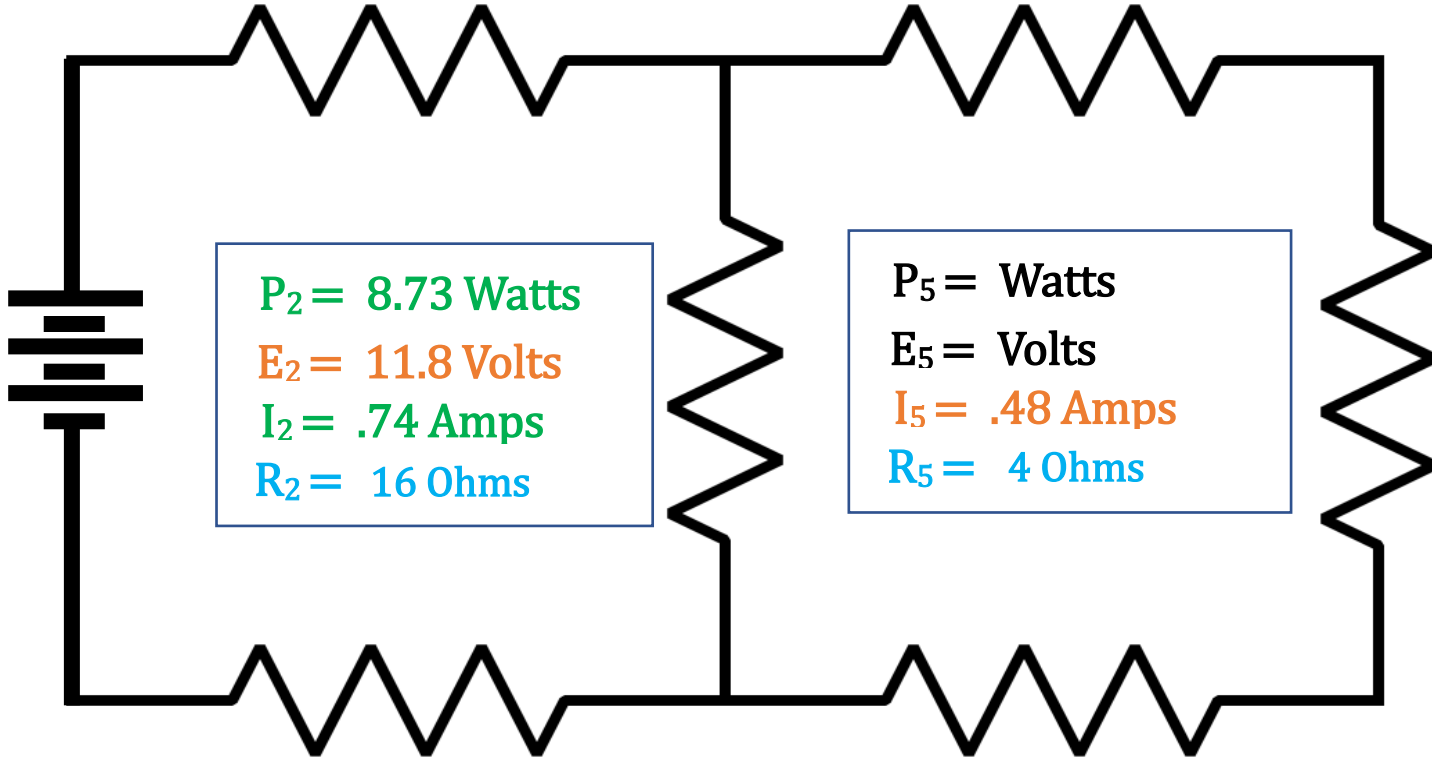

$P_2 = 8.73$ Watts
 $E_2 = 11.8$ Volts
 $I_2 = .74$ Amps
 $R_2 = 16$ Ohms

$P_5 =$ Watts
 $E_5 =$ Volts
 $I_5 = .48$ Amps
 $R_5 = 4$ Ohms

$P_3 = 8.93$ Watts
 $E_3 = 7.32$ Volts
 $I_3 = 1.22$ Amps
 $R_3 = 6$ Ohms

$P_6 =$ Watts
 $E_6 =$ Volts
 $I_6 = .48$ Amps
 $R_6 = 18$ Ohms

Math

Rule

$P_T = 29.28$ Watts
 $E_T = 24$ Volts
 $I_T = 1.22$ Amps
 $R_T = 19.6$ Ohms

$P_1 = 5.95$ Watts
 $E_1 = 4.88$ Volts
 $I_1 = 1.22$ Amps
 $R_1 = 4$ Ohms

$P_4 = .46$ Watts
 $E_4 = .96$ Volts
 $I_4 = .48$ Amps
 $R_4 = 2$ Ohms

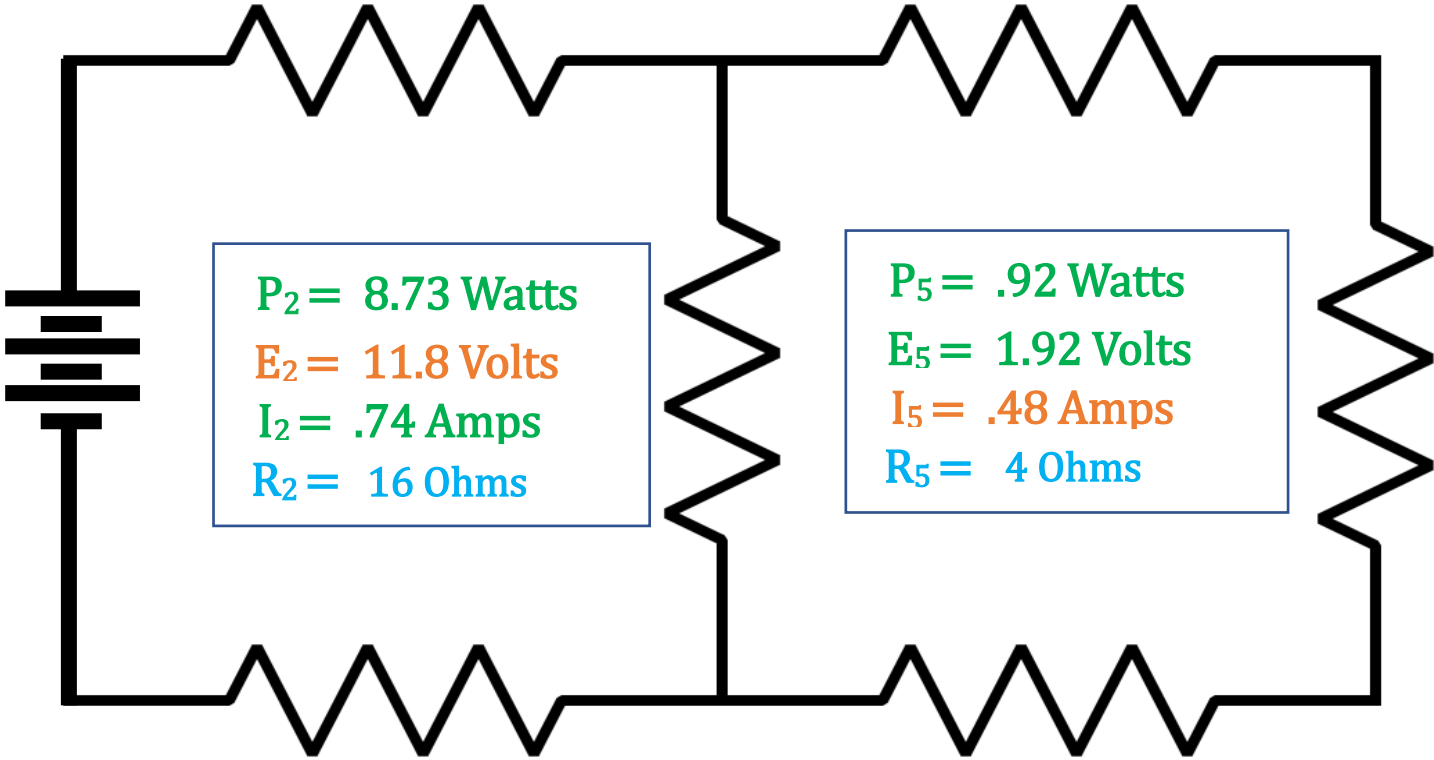

$P_2 = 8.73$ Watts
 $E_2 = 11.8$ Volts
 $I_2 = .74$ Amps
 $R_2 = 16$ Ohms

$P_5 = .92$ Watts
 $E_5 = 1.92$ Volts
 $I_5 = .48$ Amps
 $R_5 = 4$ Ohms

$P_3 = 8.93$ Watts
 $E_3 = 7.32$ Volts
 $I_3 = 1.22$ Amps
 $R_3 = 6$ Ohms

$P_6 =$ Watts
 $E_6 =$ Volts
 $I_6 = .48$ Amps
 $R_6 = 18$ Ohms

Math

Rule

$P_T = 29.28$ Watts
 $E_T = 24$ Volts
 $I_T = 1.22$ Amps
 $R_T = 19.6$ Ohms

$P_1 = 5.95$ Watts
 $E_1 = 4.88$ Volts
 $I_1 = 1.22$ Amps
 $R_1 = 4$ Ohms

$P_4 = .46$ Watts
 $E_4 = .96$ Volts
 $I_4 = .48$ Amps
 $R_4 = 2$ Ohms

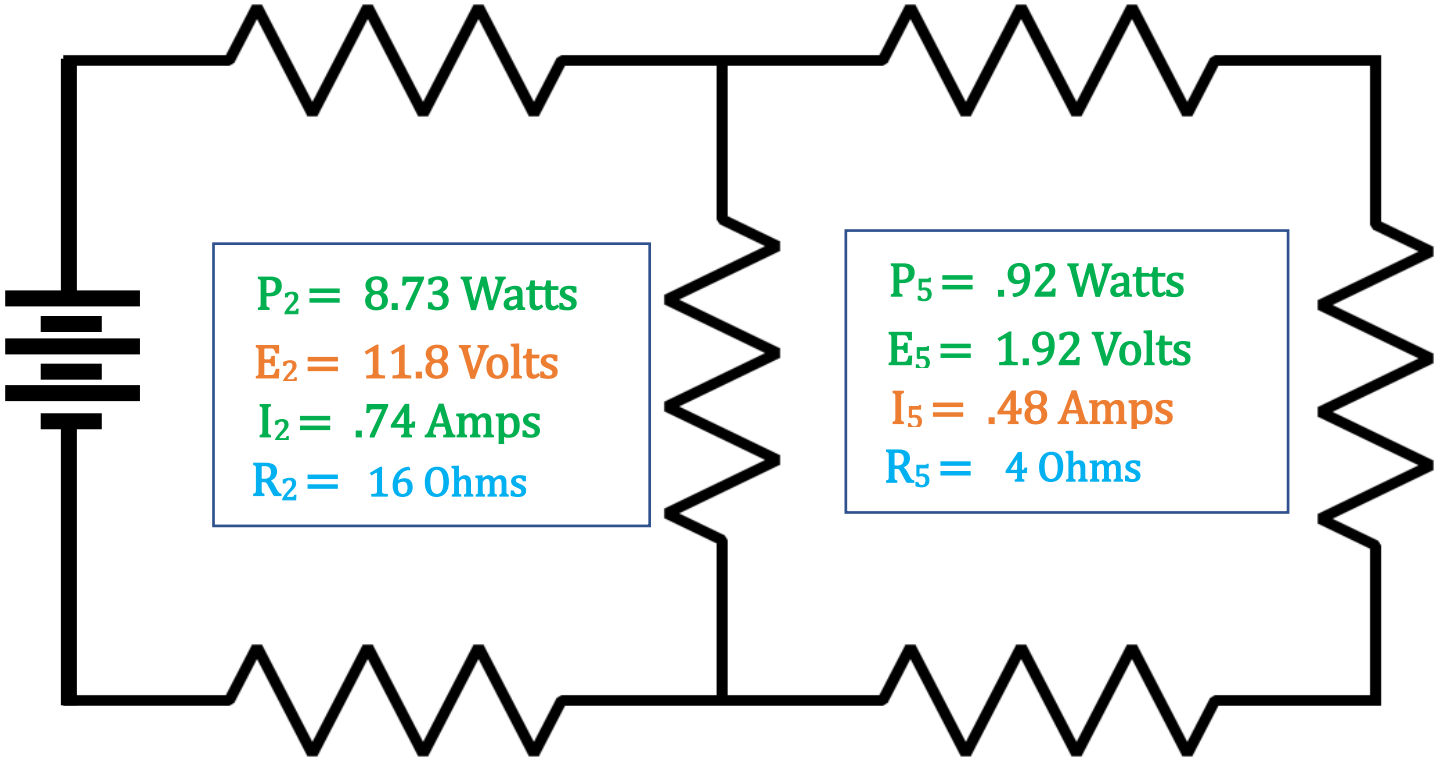

$P_2 = 8.73$ Watts
 $E_2 = 11.8$ Volts
 $I_2 = .74$ Amps
 $R_2 = 16$ Ohms

$P_5 = .92$ Watts
 $E_5 = 1.92$ Volts
 $I_5 = .48$ Amps
 $R_5 = 4$ Ohms

$P_3 = 8.93$ Watts
 $E_3 = 7.32$ Volts
 $I_3 = 1.22$ Amps
 $R_3 = 6$ Ohms

$P_6 = 4.15$ Watts
 $E_6 = 8.64$ Volts
 $I_6 = .48$ Amps
 $R_6 = 18$ Ohms